

Varenummer: 0106043
 Beskrivelse: Seeger låsering JV 26

Mål

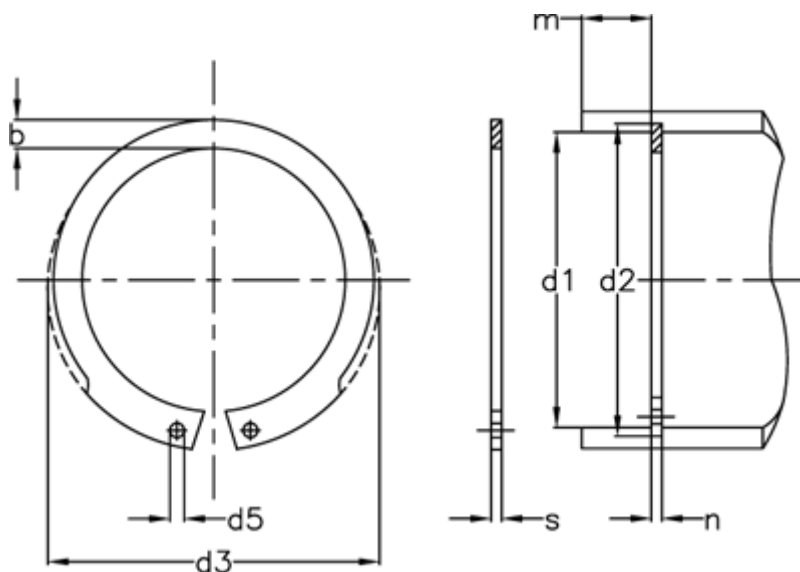

AN mm ²	= 25	FRg kN	= 5.2	Tang	= ZGJ-1
b	= 3.0	FR kN	= 15.3	tol	= -0.06
Betegnelse	= JV 26	g	= 1.0	tol	= +0,42-0,21
d1	= 26	K kN-mm	= 31.4	tol	= +0,21
d2	= 27.2	m min	= 1.30	tol	= 0.1
d3	= 27.9	Nominel træk	= 2.1	vægt kg/1000	= 1.50
d5 min	= 1.5	s	= 1.20		
FN kN	= 4.17	t	= 0.60		